

Operation Positioning Gel Pads

New Product Catalog

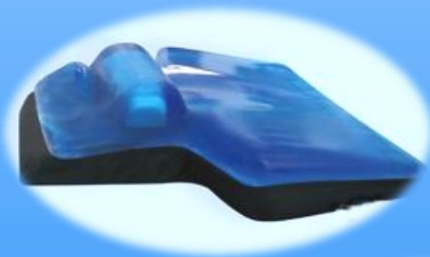
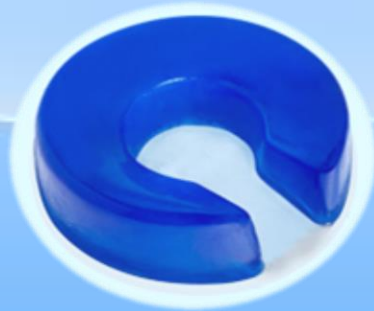
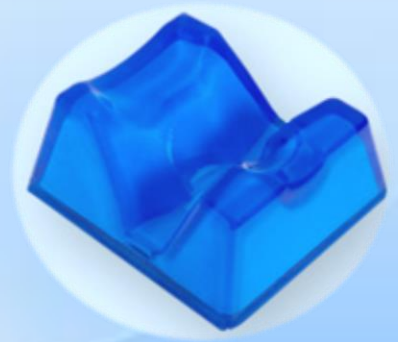
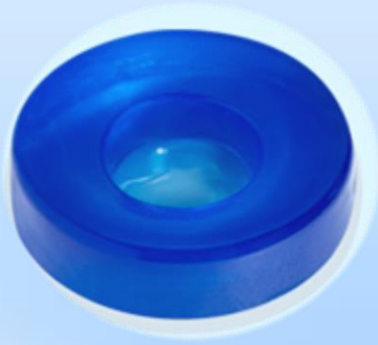

(주) 대 석 메 드

서울시 영등포구 경인로775 에이스하이테크시티 1동 326호

T: (02) 6309-4343~7 F: (02) 6309-4348 Web: www.daeseuk.com

Prostrate Pads



Prostrate Pads		
엎드린 자세에서 목과 요추 수술 시, 가슴 압박을 최소화 하여 호흡 및 혈액순환을 도와줌.		
Model	특징	Size(cm)
3102-1	Sponge Base	63 x 46 x 13
3102-3	Foam Base	60 x 49 x 18

Adjustable Prostrate Head Pad

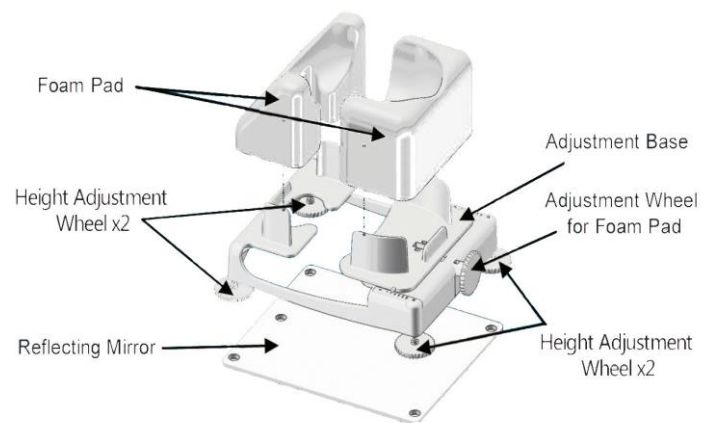

Model: 1101-17

- ▣ 제품 특징
- 상하 높낮이 : 0 ~ 28mm 조절 가능
- Foam 간격 : 15mm ~ 70mm 조절 가능

Head and Neck Pads



1101-1

※ Foam 내장
형태를 바르게 지지



1101-3 / 1101-9 / 1101-13



1101-14



Donut Head Pads

이비인후과, 성형외과, 안과 등
수술 및 시술 시 머리 지지

Model	특징	Size(cm)
1102-1	Adult	20 x 7 x 7
1102-2	Adult	20 x 7 x 5
1102-6	Adult	20 x 7 x 3
1102-7	Pediatric	14 x 7 x 2.5
1102-3	Pediatric	14 x 5 x 3
1102-8	Pediatric	14 x 5 x 2.5
1102-4	Pediatric	10 x 4 x 2.5
1102-5	Neonatal	8 x 3 x 2

Prostrate Head Pads

전신마취 시 엎드린 자세의 수술에서
머리, 이마, 얼굴의 보호 및 호흡통로를 확보.

Soft Gel Pads

Model	특징	Size(cm)
1101-1	Foam inside	28 x 24 x 14

Soft/Hard Gel Combination Pads

(얼굴 닿는 부분: 부드러운 Gel, 하단부: 단단한 Gel)

Model	특징	Size(cm)
1101-3	Adult	23 x 20 x 11.5
1101-9	Pediatric	21 x 18 x 11

Sponge Pads

Model	특징	Size(cm)
1101-14	Sponge	30 x 24 x 15

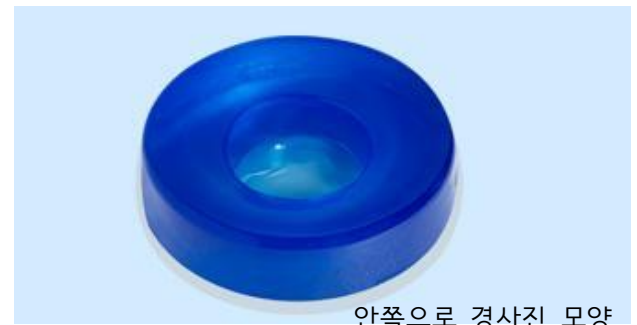

안쪽으로 경사진 모양

Bowl Shaped Head Pads

전신마취 시 신경외과 및 이비인후과에서
수술할 때에 머리 지지

Model	특징	Size(cm)
1107-3	Adult	8.5 x 3 / 20 x 5
1107-1	Adult	8 x 2 / 20 x 5
1107-2	Pediatric	6 x 1.5 / 14 x 3

Head and Neck Pads

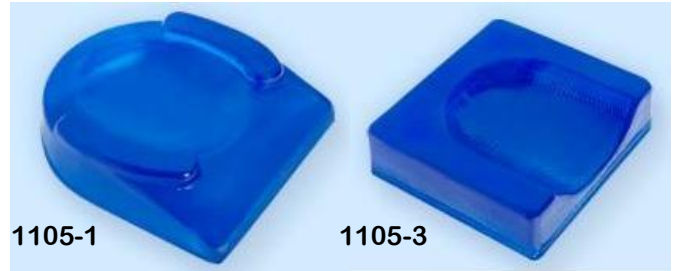

Horseshoe Head Pads

전신마취 시 옆으로 누운 수술에서 호흡통로 확보

Model	특징	Size(cm)
1103-1	Adult	20 x 7 x 7
1103-2	Adult	20 x 7 x 5
1103-6	Adult	20 x 7 x 3
1103-3	Pediatric	14 x 5 x 3
1103-4	Pediatric	10 x 4 x 2.5
1103-5	Neonatal	8 x 3 x 2

Ophthalmic Head Pads

안과 및 얼굴, 턱 관절 수술 시 머리 지지

Model	Size(cm)
1105-1	23 x 23 x 4
1105-2	22 x 19 x 6
1105-3	24 x 22 x 7 (3.3)



안쪽으로 경사진 모양

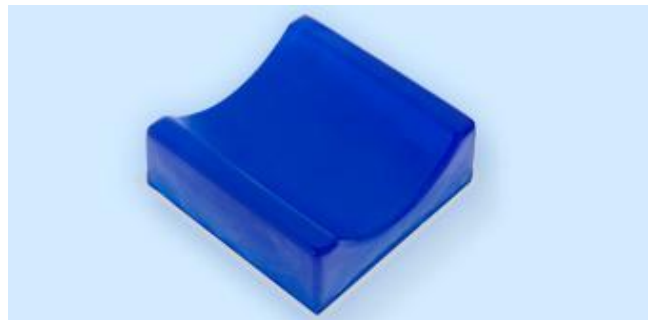

Bowl Shaped Horseshoe Head Pads

수술할 때의 전신마취 유도 시 머리 지지

Model	특징	Size(cm)
1108-1	Adult	20 x 5.5
1108-2	Pediatric	14 x 3.5

Universal Supine Head Pads

수평자세 수술 시 머리와 목 보호 및 지지

Model	Size(cm)
1104	18 x 18 x 8 (4)

Head and Neck Pads

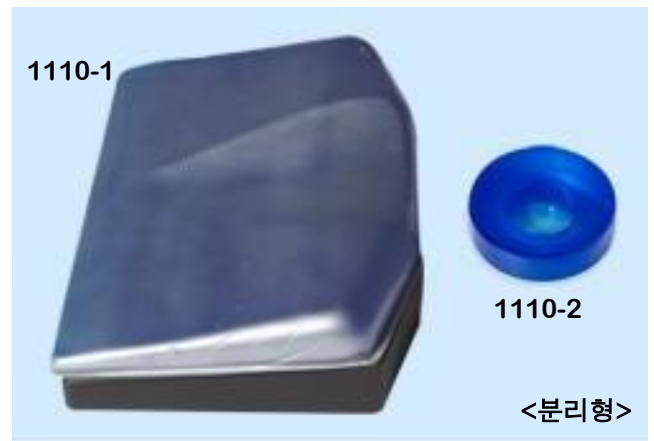
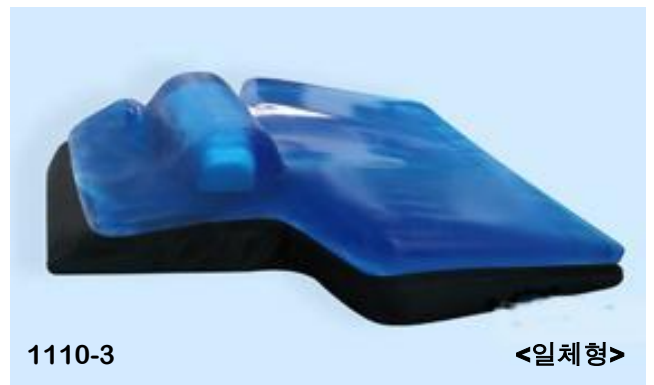

Universal Flat Head Pads	
머리 및 등의 보호 및 지지	
Model	Size(cm)
1106-3	45 x 15 x 10
1106-1	25 x 23 x 6
1106-2	25 x 18 x 3

Thyroid Gland Positioning Pads	
갑상선 및 목 관련 수술 시 목을 보호 및 지지하며 수술 시야를 확대함	
Model	Size(cm)
1110-1	40 x 30 x 5 (12)
1110-2	6 x 3 / 14 x 4.5
1110-3	48 x 39 x 9

Arm and Shoulder Pads



Universal Armboard Pads

팔꿈치, 팔뚝 등 팔 부위 보호

Model	Size(cm)
2101-2	60 x 16 x 1
2101-1	40 x 16 x 1
2101-3	75 x 16 x 2



Elbow Protectors

팔꿈치 및 척골신경 보호

Model	Size(cm)
2102	40 x 15 x 1.5



Wrist Protectors

손목을 고정 및 지지하여 보호

Model	Size(cm)
2103-1	32 x 5 x 1
2103	25 x 5 x 1



Lateral Pads

옆으로 누워 하는 수술 시
어깨와 팔에 가해지는 압력의 완화

Model	특징	Size(cm)
3101-1	Sponge Base	72 x 46 x 15
3101-2	Foam Base	70 x 50 x 16

Chest and Body Pads



Body Protectors

몸과 관절부위의 고정 및 지지

Model	Size(cm)
3106	60 x 7 x 1



Chest-Hipbone Pads

엎드려 하는 수술 시
가슴 및 관골(Hipbone)에 가해지는 압력 완화

Model	특징	Size(cm)
3103	-	50 x 20 x 7
3103-1	Foam inside	50 x 20 x 7
3103-2	Pediatric	7 x 4 x 4

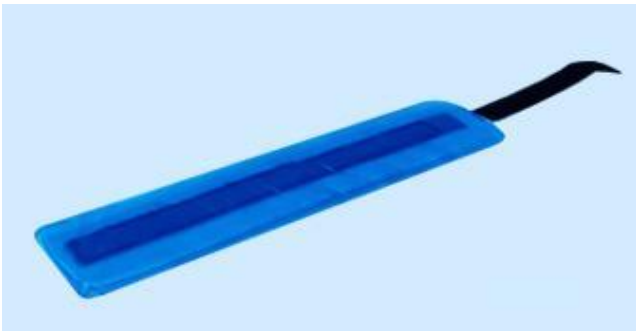

Ankle Protectors

발목을 고정 및 지지하여 보호

Model	Size(cm)
4105	45 x 7 x 1

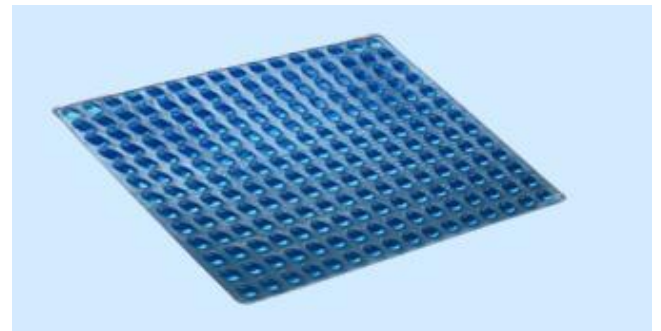

3104-2

Haemorrhoid Seat Cushions

치질, 치핵 관련 수술 후 환자의 앉는 자세
하에서의 고통완화를 위한 방식

Model	Size(cm)
3104-2	40 x 30 x 5

Wheel Chair Seat Pads

엉치뼈에 가해지는 압력 완화

Model	Size(cm)
3104-7	50 x 41 x 2.8
3104-1	50 x 40 x 1.8
3104-6	46 x 41 x 2.8
3104-5	46 x 41 x 1.8
3104-4	43 x 41 x 1.8
3104-3	40 x 41 x 1.8

Chest and Body Pads



Pillar Shaped Pads	
발목, 무릎, 어깨 보호 및 지지	
Model	Size(cm)
3109-1	50 x 12 x 10
3109-2	40 x 12 x 10
3109-3	30 x 12 x 10
3109-4	20 x 12 x 10
3109-5	10 x 5 x 5

Slanting Shaped Pads	
옆으로 누운 자세 및 수평자세 수술 시 요추, 간, 비장 부위 수술 시야 확대	
Model	Size(cm)
3107-3	30 x 22 x 5 / 1
3107-1	30 x 18 x 7 / 3
3107-2	25 x 15 x 6 / 2

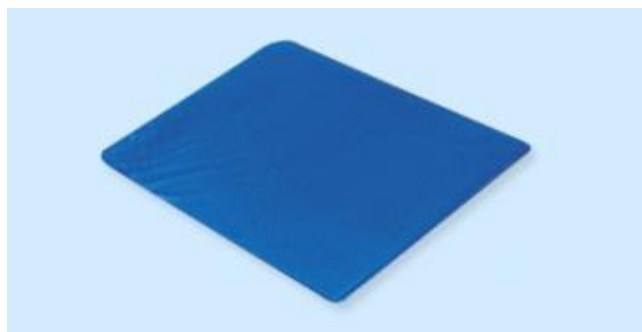

Hip Pads	
엉치뼈에 가해지는 압력 완화	
Model	Size(cm)
3104	50 x 40 x 1.5

Lower Limb Pads

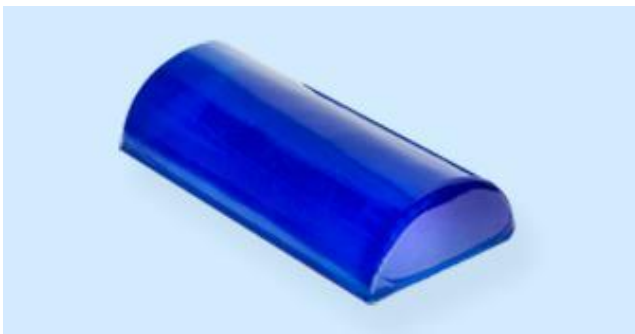

Dome Shaped Pads

여러 자세의 수술에서 사용 가능 하며,
가슴, 관골, 무릎, 발목, 겨드랑이 등 보호 및 지지

Model	특징	Size(cm)
4101-14	-	50 x 15 x 12
4101-12	-	50 x 15 x 10
4101-3	-	50 x 15 x 7
4101-8	Foam inside	50 x 15 x 7
4101-13	-	50 x 10 x 10
4101-6	-	50 x 10 x 7
4101-4	-	50 x 10 x 4
4101-11	-	40 x 15 x 7
4101-17	-	40 x 15 x 4
4101-16	-	30 x 22 x 5
4101-1	-	30 x 15 x 7
4101-7	Foam inside	30 x 15 x 7
4101-5	-	30 x 10 x 7
4101-2	-	30 x 10 x 4
4101-9	-	20 x 15 x 7
4101-10	Pediatric	20 x 10 x 7

Lower Limb Pads

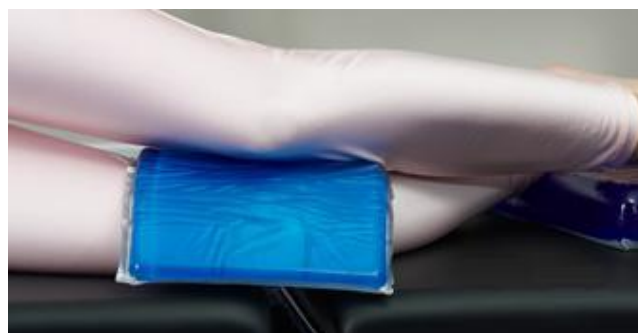

Lateral Arm/Leg Pads	
무릎과 팔의 보호 및 지지	
Model	Size(cm)
4102-3	60 x 15 x 4
4102-1	50 x 15 x 4
4102-2	40 x 15 x 4

Universal Square Pads	
어깨, 관절, 무릎 등 보호 및 지지	
Model	Size(cm)
4104-3	50 x 30 x 1.5
4104-5	50 x 15 x 3
4104-2	40 x 24 x 1.5
4104-1	30 x 20 x 1.5
4104-4	17 x 11 x 1.5

Lower Limb Pads

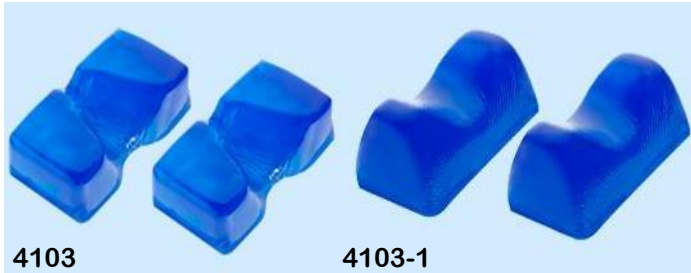

4103

4103-1

Heel Pads	
발목 및 발꿈치 보호 및 지지	
Model	Size(cm)
4103-1	18 x 10 x 7
4103	15 x 8 x 4.5

O.R. Table Pads		
수술대와 호환되며, 압박을 최소화함		
Model	특징	Size(cm)
5101-1	Head	50 x 23 x 1.5
5101-2	Torso	100 x 50 x 1.5
5101-6	Torso w/Cutout	100 x 50 x 1.5
5101-3	Foot	50 x 50 x 1.5
5101-7	Foot w/Cutout	50 x 50 x 1.5
5101	Full O.R. Table Pads	



Lateral Positioning Surgery
Horseshoe Head Pads
Lateral Arm/Leg Pads
Lateral Pads
Body Protectors
Dome Shaped Pads
Universal Square Pads
Universal Flat Head Pads



Supine Positioning Surgery
Horseshoe Head Pads
Lateral Arm/Leg Pads
Slanting Shaped Pads
Dome Shaped Pads